

14. **Build Out First Short Side** – Continue assembly of the post and rail using the method described above. The guide string between the corner stakes is used to keep the line straight as you build to the next corner.

15. **Build Out Second Long Side** – As above.

16. **Build Out Second Short Side and Gate Area** – As above. Use the end posts for entrance gate.

17. **Hammer In Stakes** – Hammer in all stakes till they are flush with the top of the posts. CAUTION: Hitting the PVC post with your hammer may damage the post.

18. **Place Caps on Posts** – Secure caps on post tops. Use decorative caps on end posts at entrance gate.

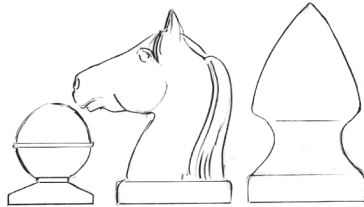

Maintaining Your New Dressage Arena

To clean your arena use warm water and a mild detergent like dishwashing soap. Use a large sponge or soft cloth because abrasives may scratch the finish. To get out real stubborn stains you can use mineral spirits followed by a water rinse. Be careful because mineral spirits can damage the finish if left on too long.



800.611.6109
www.dressagearena.net



PREMIER
Equestrian™

SET-UP INSTRUCTIONS FOR 20x60 CLASSIC ARENA W/POST ANCHOR SYSTEM

If you should have any difficulty or question please call us at 800-611-6109. Please take a moment to read through the entire directions before setting up your Premier Equestrian Arena. These instructions will guide you step-by-step through the process of assembly.

Included in your shipment:

- 56 Rails
- 50 Line Posts
- 4 Corner Posts
- 2 End Posts
- 2 Decorative Gate Caps
- 54 Post Caps
- 56 Post Stakes
- 2 Gate Sleeves w/screws

21 sections on 60 meter side
7 sections on 20 meter side

What you need:

- Hammer
- 60 Meter Tape Measurer
- 160 Meters of String
- Screwdriver (Phillips head)

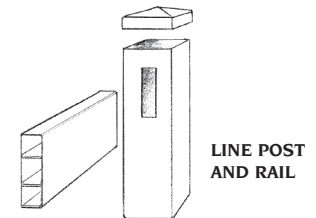

PREPARATION

1. Drag or blade the arena area — as level and smooth as possible.
2. Locate and count all parts. Separate line posts, corner posts, and end posts.



3. **Deposit Rails and Posts** – place the pieces around the outside perimeter where the arena will stand. This is to get the pieces close to where they will be installed.

4. **Optional Gate Sleeves** – If you want to be able to close your entrance gate you will have to attach the gate sleeves to the end posts. The gate sleeves hold the rail for your gate. See figure (1).

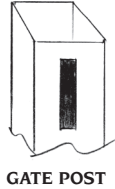

GATE POST

Layout Your Arena

5. **Find the Center Point** – Measure from edge to edge of the long side. Mark the center point. Measure from edge to edge of the short side and mark the center point. Bring the center points together to find the center of your arena.

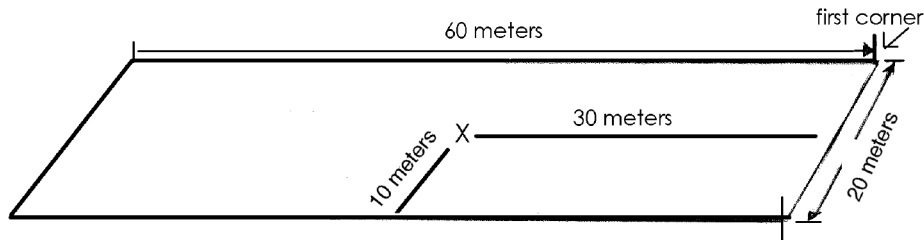

6. **Locate Short Side Line** – From the center point measure 30 meters toward the short side, this is where your short side will line up.

7. **Locate Long Side Line** – From the center point measure 10 meters toward the long side, this is where your long side will line up.

8. **Locate First Corner** – At the point where the two side lines intersect is the corner of your arena. Insert a stake at this point, make sure the stake is solidly in the ground with about 18" exposed. Place a corner post over this stake. 1" - 2" of the stake should extend above the post to allow the guide string room to tie.

9. **Locate Second Corner, Layout First Long Side** – From the first corner stake, measure down the long side to 60 meters. Keep in mind the center point of the arena to make the line square with the footing. Insert a stake at this point and place a corner post over the stake. Tie a string between the two stakes. This is your first long side.

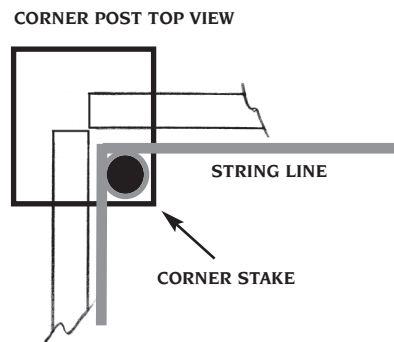

10. **Layout First Short Side** – From the second corner, measure across the short side 20 meters. Use the 3-4-5 formula (figure 2) to get the corner square. Use a Corner post and a stake at this point. Now tie a string between the two stakes. This is your first short side.

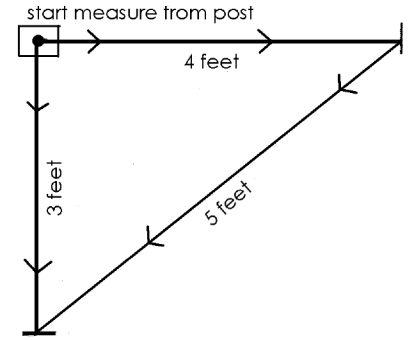

11. **Layout Second Short Side** – From the first corner, measure across the short side 20 meters. Use the 3-4-5 formula (figure 2) to get the corner square. Place a stake at this point and place a corner post onto the stake. Now tie a string between the two stakes. This is your second short side.

12. **Layout Second Long Side** – Tie a string between the two stakes to layout your second long side. You may need to adjust one of the short side stakes to get the arena square.

Now is the time to overview where your Dressage Arena is located. If you don't like the positioning make the necessary adjustments.

Arena Assembly

13. **Build Out the First Long Side** – Place a rail into the corner post, extending about half way into the post. Place a line post on the other end of the rail. Place a stake into the line post. (Do not hammer stake into ground until entire arena is set in place.) Place another rail into the line post. Make sure all rails butt up against each other for an accurate size arena. All rails should be touching. Repeat these steps until you are at the Second Corner.

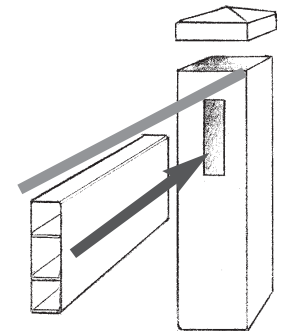

NOTE: You may need to adjust the position of the second corner after building out the first long side. This is normal and is due to the variations of measuring out the arena. When the arena is set-up correctly the measurement from inside rail to inside rail will be 60 meters on the long side and 20 meters on the short side.